

BONDEK[®] STRUCTURAL STEEL DECK

USER GUIDE FOR CONCRETE
CONSTRUCTION PROFESSIONALS

LYSAGHT



BONDEK® STRUCTURAL STEEL DECK USER GUIDE

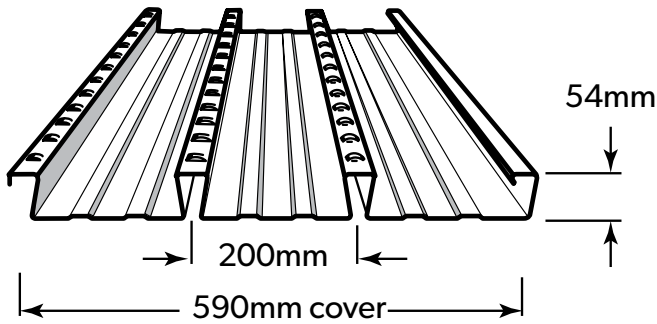

USING LYSAGHT® BONDEK® STRUCTURAL STEEL DECK

BONDEK® Structural Steel Decking is a highly efficient, versatile and robust formwork, reinforcement and ceiling system for concrete slabs. It is a profiled steel sheeting widely accepted by the building and construction industry to offer efficiency and speed of construction. It has re-entrant ribs into the concrete slab at approximate 200mm centres and its depth is 54mm. It is available in a Base Metal Thicknesses (BMT) 0.6, 0.75, 0.9 and 1.0mm.

This manual is to be used in conjunction with the BONDEK® Structural Steel Decking Design and Construction Manual - and forms a practical construction handbook, rather than a design manual.

Designs can be adopted from the BONDEK® Structural Steel Decking Design and Construction Manual, in conjunction with a consulting structural engineer.

Topics in this guide include construction and formwork tables.

Our newest release of supporting software and the Design and Construction Manual for BONDEK® Structural Steel Decking incorporates Lysaght's latest research and development work. Improved design and testing methods have again pushed BONDEK® Structural Steel Decking to the forefront. New formwork tables are optimised for steel frame construction but are also suitable for concrete frame construction and masonry walls.

Please consult formwork General Notes when using concrete framed or masonry wall construction and refer to the Design and Construction Manual.

BONDEK® steel decking permits installation of suspended services and ceilings without drilling into the concrete slab. A reliable interlocking mechanism provides vertical lapping for faster installation. BONDEK® steel deck has a durable galvanised coating.

DESIGN ADVANTAGES INCLUDE:

- Excellent spanning capacities for greater strength and less deflection
- Acts as permanent formwork with minimal propping and no stripping of formwork face is required
- Fast and easy to install (590mm wide) with less handling required
- Works as reinforcement with composite slab saving on concrete and reinforcement costs
- Ribs at 200mm centres creating a safe working platform with slip resistant embossments on the ribs
- Advanced design for fire resistance
- New BONDEK® design software gives added flexibility and ease of design
- Backed by a BlueScope Steel warranty
- Nationwide technical support

MATERIAL SPECIFICATIONS

Thickness mm	Mass		Yield Strength MPa	Coverage m ² /t
	kg/m ²	kg/m		
0.60	8.52	5.03	550	117.31
0.75	10.50	6.19	550	95.24
0.90	12.48	7.36	550	80.16
1.00	13.79	8.14	550	72.50

BONDEK® profiled steel decking is roll-formed from hot dipped, zinc-coated, hi-tensile steel strip, in Base Metal Thicknesses (BMT) of 0.60, 0.75, 0.90 and 1.0mm. The steel strip conforms to AS 1397 grade G550, Z350.

0.9mm thickness is available for projects by special order.

Pre-painted BRITEWHITE® soffit is also available on enquiry.

CERTIFICATION OF FORMWORK

LYSAGHT® certifies that the information contained within this Specification complies with Section B of the Building Code of Australia and with the relevant Australian Standards.

This specification has been based on the exclusive use of BONDEK® manufactured by LYSAGHT®.

Figure 1

BONDEK® sheets continuous over single slab span.

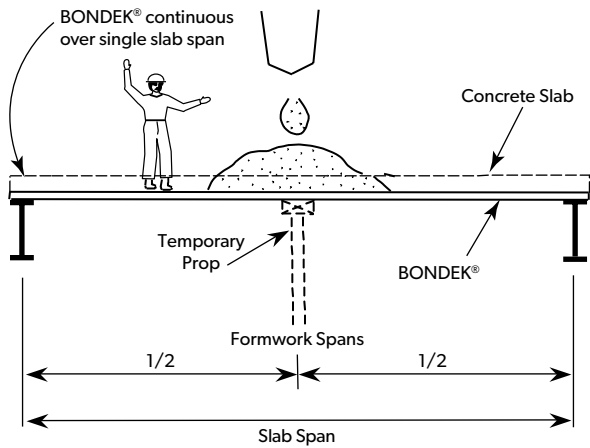

Figures 1, 2 and 3 are simply to illustrate typical propping configuration within a slab span to achieve equal spans of the BONDEK® during the formwork stage.

Figure 2

BONDEK® sheet continuous over 2 slab spans.

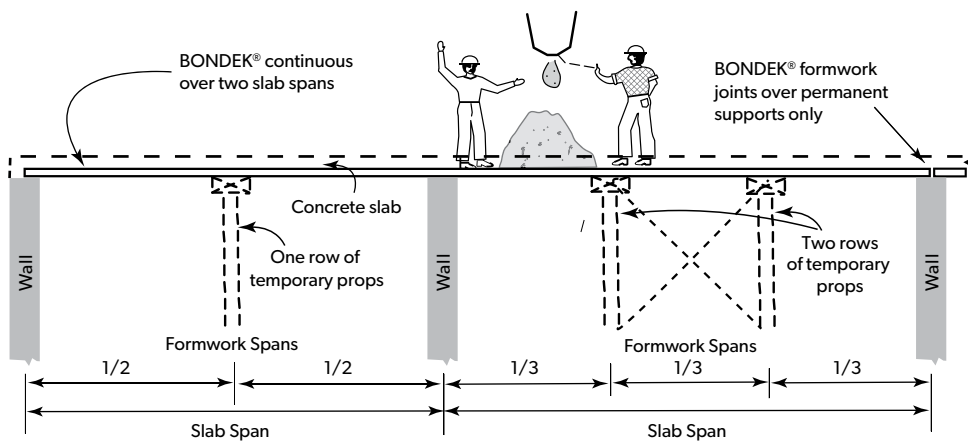
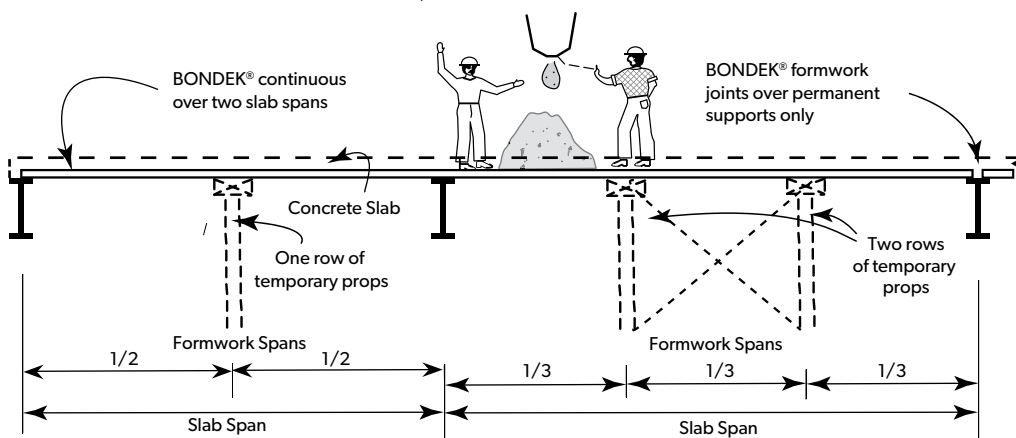
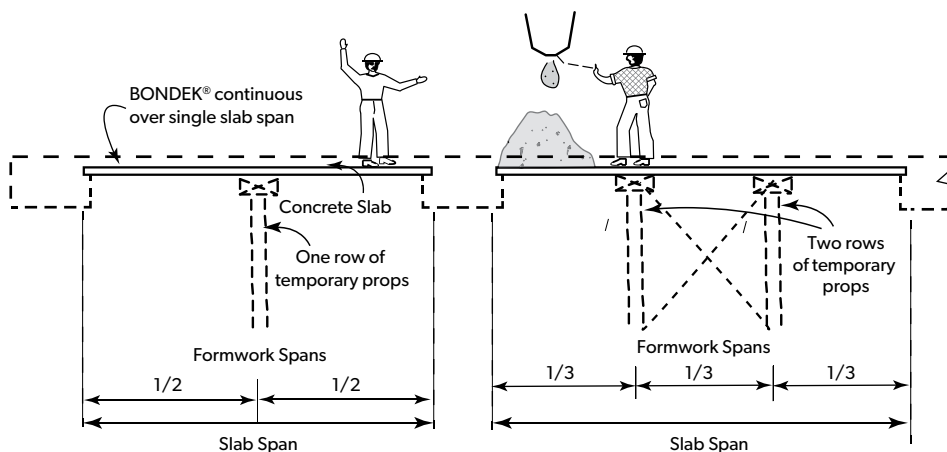

Figure 3

Concrete frame construction. BONDEK® sheet continuous over single slab span.



FORMWORK/SLAB SPAN TABLES

Maximum slab spans, mm

BONDEK® sheets continuous over single slab span

Formwork deflections limits L/240 (Visual appearance important)

Slab Depth D (mm)	0.6 BMT BONDEK® No of props per span			0.75 BMT BONDEK® No of props per span			0.9 BMT BONDEK® No of props per span			1.0 BMT BONDEK® No of props per span		
	0	1	2	0	1	2	0	1	2	0	1	2
100	2000	4950	7350	2150	5850	8150	2250	6300	8700	2350	6500	9050
110	1900	4750	7150	2050	5700	7900	2200	6100	8450	2250	6350	8800
120	1800	4650	6900	2000	5550	7700	2150	5950	8250	2200	6150	8550
130	1750	4500	6650	1950	5400	7500	2100	5800	8050	2150	6000	8350
140	1700	4400	6400	1900	5300	7300	2050	5650	7850	2100	5900	8100
150	1650	4300	6200	1850	5200	7100	2000	5550	7600	2050	5750	7900
160	1600	4250	6050	1750	5050	6900	1900	5450	7400	2000	5650	7700
170	1550	4150	5850	1750	5000	6750	1850	5300	7250	1950	5550	7500
180	1550	4050	5700	1700	4900	6550	1850	5200	7050	1900	5400	7350
190	1500	4000	5550	1650	4750	6400	1800	5100	6900	1850	5300	7200
200	1450	3900	5400	1600	4650	6250	1750	5000	6750	1850	5200	7050
210	1400	3850	5300	1550	4550	6150	1700	4900	6600	1800	5050	6900
220	1400	3800	5200	1550	4450	6000	1650	4800	6500	1750	5000	6800
230	1350	3750	5050	1500	4350	5900	1650	4700	6400	1700	4900	6650
240	1350	3700	4950	1500	4300	5800	1600	4600	6250	1700	4800	6550
250	1300	3600	4850	1450	4200	5650	1600	4550	6150	1650	4750	6450

Maximum slab spans, mm

BONDEK® sheets continuous over single slab span

Formwork deflections limits L/130 (Visual appearance not important)

Slab Depth D (mm)	0.6 BMT BONDEK® No of props per span			0.75 BMT BONDEK® No of props per span			0.9 BMT BONDEK® No of props per span			1.0 BMT BONDEK® No of props per span		
	0	1	2	0	1	2	0	1	2	0	1	2
100	2100	4800	7200	2550	5900	8850	2700	7100	10000	2800	7700	10000
110	2050	4700	7050	2500	5750	8650	2650	6900	10000	2700	7450	10000
120	2000	4550	6850	2450	5600	8400	2550	6700	9850	2650	7300	10000
130	1950	4450	6700	2350	5450	8200	2500	6550	9650	2600	7100	10000
140	1950	4350	6550	2300	5350	8050	2450	6400	9450	2550	6950	9800
150	1900	4250	6400	2250	5250	7850	2400	6250	9250	2500	6800	9600
160	1850	4200	6300	2200	5100	7700	2350	6100	9100	2450	6650	9450
170	1800	4100	6150	2200	5000	7550	2300	6000	8900	2400	6500	9250
180	1800	4050	6050	2150	4950	7400	2250	5900	8750	2350	6400	9100
190	1750	3950	5950	2100	4850	7250	2250	5750	8650	2300	6250	8950
200	1750	3900	5850	2050	4750	7150	2200	5650	8500	2250	6150	8800
210	1700	3850	5750	2050	4700	7050	2150	5550	8350	2250	6050	8700
220	1700	3750	5650	2000	4600	6900	2150	5500	8250	2200	5950	8550
230	1650	3700	5550	2000	4550	6800	2100	5400	8100	2200	5850	8450
240	1650	3650	5500	1950	4450	6700	2050	5300	7950	2150	5750	8350
250	1600	3600	5400	1900	4400	6600	2050	5250	7850	2100	5650	8200

Notes:

1. These are formwork selection tables only. Maximum slab spans in these tables shall be designed by a qualified structural engineer.
2. Use BONDEK® design software for support widths other than 100mm.
3. 1 kPa Live Load due to stacked materials is used - this shall be indicated on formwork documentation and controlled on-site.
4.  The availability of 0.9mm BMT BONDEK® is subject to enquiry.
5. Refer to General Engineering Notes when using these tables.

Maximum slab spans, mm

BONDEK® sheets continuous over 2 slab spans

Formwork deflections limits L/240 (Visual appearance important)

Equal slab spans

Slab depth D (mm)	0.6 BMT BONDEK® No of props per span			0.75 BMT BONDEK® No of props per span			0.9 BMT BONDEK® No of props per span			1.0 BMT BONDEK® No of props per span		
	0	1	2	0	1	2	0	1	2	0	1	2
100	2450	4900	7350	2900	5550	8350	3150	5900	8900	3250	6150	9250
110	2350	4750	7150	2850	5400	8100	3050	5750	8650	3150	5950	8950
120	2300	4650	6950	2750	5250	7850	2950	5600	8400	3050	5800	8750
130	2250	4500	6800	2700	5100	7650	2900	5450	8200	3000	5650	8500
140	2200	4400	6600	2650	5000	7500	2800	5350	8000	2950	5550	8300
150	2150	4250	6400	2600	4850	7300	2750	5200	7800	2850	5400	8100
160	2100	4150	6200	2500	4750	7100	2700	5050	7600	2800	5250	7900
170	2050	4000	6050	2500	4600	6950	2650	4950	7400	2750	5150	7700
180	2000	3900	5900	2450	4500	6750	2600	4800	7250	2700	5000	7550
190	2000	3800	5750	2350	4400	6600	2550	4700	7100	2650	4900	7350
200	1950	3700	5600	2300	4300	6450	2500	4600	6950	2600	4800	7200
210	1900	3650	5450	2250	4200	6300	2450	4500	6800	2500	4700	7100
220	1900	3550	5350	2200	4100	6200	2400	4450	6650	2500	4600	6950
230	1850	3450	5200	2150	4050	6050	2350	4350	6550	2450	4550	6850
240	1800	3400	5100	2150	3950	5950	2300	4300	6450	2400	4450	6700
250	1800	3350	5000	2100	3900	5850	2250	4200	6300	2350	4400	6600

Maximum slab spans, mm

BONDEK® sheets continuous over 2 slab spans

Formwork deflections limits L/130 (Visual appearance not important)

Equal slab spans

Slab Depth D (mm)	0.6 BMT BONDEK® No of props per span			0.75 BMT BONDEK® No of props per span			0.9 BMT BONDEK® No of props per span			1.0 BMT BONDEK® No of props per span		
	0	1	2	0	1	2	0	1	2	0	1	2
100	2400	4800	7200	2950	5900	8850	3550	7050	10000	3850	7300	10000
110	2350	4700	7050	2850	5750	8650	3450	6850	10000	3700	7100	10000
120	2250	4550	6850	2800	5600	8400	3350	6700	10000	3650	6950	10000
130	2200	4450	6700	2700	5450	8200	3250	6550	9800	3550	6800	10000
140	2150	4350	6550	2650	5350	8050	3200	6400	9600	3450	6650	10000
150	2100	4250	6400	2600	5250	7850	3100	6250	9400	3400	6550	9800
160	2100	4200	6300	2550	5100	7700	3050	6100	9200	3300	6400	9600
170	2050	4100	6150	2500	5000	7550	3000	6000	9000	3250	6300	9450
180	2000	4050	6050	2450	4950	7440	2950	5900	8850	3200	6200	9300
190	1950	3950	5950	2400	4850	7250	2850	5750	8650	3100	6100	9150
200	1950	3900	5850	2350	4750	7150	2800	5650	8500	3050	6000	9000
210	1900	3850	5750	2350	4700	7050	2750	5550	8350	3000	5900	8850
220	1850	3750	5650	2300	4600	6900	2750	5500	8250	2950	5800	8750
230	1850	3700	5550	2250	4550	6800	2700	5400	8100	2900	5750	8650
240	1800	3650	5500	2200	4450	6700	2650	5300	7950	2850	5650	8500
250	1800	3600	5400	2200	4400	6600	2600	5250	7850	2800	5600	8400

Notes:

1. These are formwork selection tables only. Maximum slab spans in these tables shall be designed by a qualified structural engineer.
2. Use BONDEK® design software for support widths other than 100mm.
3. 1 kPa Live Load due to stacked materials is used - this shall be indicated on formwork documentation and controlled on-site.
4.  The availability of 0.9mm BMT BONDEK® is subject to enquiry.
5. Refer to General Engineering Notes when using these tables.

Maximum slab spans, mm

BONDEK® sheets continuous over 3 or more slab spans

Formwork deflections limits L/240 (Visual appearance important)

Equal slab spans

Slab Depth D (mm)	0.6 BMT BONDEK® No of props per span			0.75 BMT BONDEK® No of props per span			0.9 BMT BONDEK® No of props per span			1.0 BMT BONDEK® No of props per span		
	0	1	2	0	1	2	0	1	2	0	1	2
100	2450	4900	7350	2700	5550	8350	2900	5900	8900	3000	6150	9250
110	2350	4750	7150	2600	5400	8100	2800	5750	8650	2900	5950	8950
120	2300	4650	6950	2550	5250	7850	2750	5600	8400	2850	5800	8750
130	2200	4500	6800	2500	5100	7650	2650	5450	8200	2750	5650	8500
140	2100	4400	6600	2450	5000	7500	2600	5350	8000	2700	5550	8300
150	2050	4250	6400	2350	4850	7300	2500	5200	7800	2600	5400	8100
160	2000	4150	6200	2300	4750	7100	2450	5050	7600	2550	5250	7900
170	1950	4000	6050	2250	4600	6950	2400	4950	7400	2500	5150	7700
180	1900	3900	5900	2150	4500	6750	2350	4800	7250	2450	5000	7550
190	1850	3800	5750	2100	4400	6600	2300	4700	7100	2400	4900	7350
200	1800	3700	5600	2050	4300	6450	2250	4600	6950	2350	4800	7200
210	1750	3650	5450	2050	4200	6300	2200	4500	6800	2300	4700	7100
220	1700	3550	5350	2000	4100	6200	2150	4450	6650	2250	4600	6950
230	1650	3450	5200	1950	4050	6050	2100	4350	6550	2200	4550	6850
240	1650	3400	5100	1900	3950	5950	2050	4300	6450	2150	4450	6700
250	1600	3350	5000	1850	3900	5850	2050	4200	6300	2150	4400	6600

Maximum slab spans, mm

BONDEK® sheets continuous over 3 or more slab spans

Formwork deflections limits L/130 (Visual appearance not important)

Equal slab spans

Slab Depth D (mm)	0.6 BMT BONDEK® No of props per span			0.75 BMT BONDEK® No of props per span			0.9 BMT BONDEK® No of props per span			1.0 BMT BONDEK® No of props per span		
	0	1	2	0	1	2	0	1	2	0	1	2
100	2400	4800	7200	2950	5900	8850	3450	7050	10000	3550	7300	10000
110	2350	4700	7050	2850	5750	8650	3350	6850	10000	3500	7100	10000
120	2250	4550	6850	2800	5600	8400	3250	6700	10000	3400	6950	10000
130	2200	4450	6700	2700	5450	8200	3200	6550	9800	3300	6800	10000
140	2150	4350	6550	2650	5350	8050	3150	6400	9600	3250	6650	10000
150	2100	4250	6400	2600	5250	7850	3050	6250	9400	3200	6550	9800
160	2100	4200	6300	2550	5100	7700	3000	6100	9200	3150	6400	9600
170	2050	4100	6150	2500	5000	7550	2950	6000	9000	3050	6300	9450
180	2000	4050	6050	2450	4950	7440	2900	5900	8850	3000	6200	9300
190	1950	3950	5950	2400	4850	7250	2850	5750	8650	2950	6100	9150
200	1950	3900	5850	2350	4750	7150	2800	5650	8500	2900	6000	9000
210	1900	3850	5750	2350	4700	7050	2750	5550	8350	2900	5900	8850
220	1850	3750	5650	2300	4600	6900	2750	5500	8250	2850	5800	8750
230	1850	3700	5550	2250	4550	6800	2700	5400	8100	2800	5750	8650
240	1800	3650	5500	2200	4450	6700	2650	5300	7950	2750	5650	8500
250	1800	3600	5400	2200	4400	6600	2600	5250	7850	2700	5600	8400

Notes:

1. These are formwork selection tables only. Maximum slab spans in these tables shall be designed by a qualified structural engineer.
2. Use BONDEK® design software for support widths other than 100mm.
3. 1 kPa Live Load due to stacked materials is used - this shall be indicated on formwork documentation and controlled on-site.
4.  The availability of 0.9mm BMT BONDEK® is subject to enquiry.
5. Refer to General Engineering Notes when using these tables.

Maximum slab spans, mm

BONDEK® sheets continuous over 2 slab spans

Formwork deflections limits L/240 (Visual appearance important)

Slabs spans ratio up to 1:1.2

Slab depth D (mm)	0.6 BMT BONDEK® No of props per span			0.75 BMT BONDEK® No of props per span			0.9 BMT BONDEK® No of props per span			1.0 BMT BONDEK® No of props per span		
	0	1	2	0	1	2	0	1	2	0	1	2
100	2400	4900	7250	2750	5350	8000	2950	5700	8550	3050	5950	8900
110	2350	4650	7000	2700	5200	7800	2850	5550	8300	3000	5750	8650
120	2300	4450	6700	2600	5050	7600	2800	5400	8100	2900	5600	8400
130	2200	4300	6500	2550	4900	7400	2700	5250	7900	2850	5450	8150
140	2150	4150	6250	2500	4750	7150	2650	5100	7650	2750	5300	7950
150	2100	4050	6050	2450	4600	6950	2600	4950	7450	2700	5150	7700
160	2050	3900	5900	2350	4500	6750	2500	4800	7250	2600	5000	7550
170	2000	3800	5700	2300	4350	6550	2450	4700	7050	2550	4900	7350
180	1950	3700	5550	2250	4250	6400	2400	4600	6900	2500	4800	7200
190	1900	3600	5400	2200	4150	6250	2350	4500	6750	2450	4700	7050
200	1850	3500	5300	2150	4050	6100	2300	4400	6600	2400	4600	6900
210	1800	3450	5150	2100	4000	6000	2250	4300	6450	2350	4500	6750
220	1750	3350	5050	2050	3900	5850	2200	4200	6350	2300	4400	6650
230	1750	3300	4950	2000	3800	5750	2150	4150	6250	2250	4350	6500
240	1700	3200	4850	1950	3750	5650	2150	4050	6100	2200	4250	6400
250	1650	3150	4750	1950	3700	5550	2100	4000	6050	2200	4200	6300

Maximum slab spans, mm

BONDEK® sheets continuous over 2 slab spans

Formwork deflections limits L/130 (Visual appearance not important)

Slabs spans ratio up to 1:1.2

Slab Depth D (mm)	0.6 BMT BONDEK® No of props per span			0.75 BMT BONDEK® No of props per span			0.9 BMT BONDEK® No of props per span			1.0 BMT BONDEK® No of props per span		
	0	1	2	0	1	2	0	1	2	0	1	2
100	2350	4750	7150	2900	5850	8750	3500	6800	10000	3650	7050	10000
110	2300	4650	6950	2850	5700	8550	3400	6600	9950	3550	6850	10000
120	2250	4500	6800	2750	5550	8350	3300	6450	9700	3450	6700	10000
130	2200	4450	6650	2700	5400	8150	3200	6300	9500	3400	6550	9850
140	2150	4300	6500	2650	5300	7950	3150	6200	9300	3300	6400	9650
150	2100	4250	6350	2600	5200	7800	3100	6050	9100	3250	6300	9450
160	2050	4150	6250	2500	5050	7600	3000	5950	8450	3200	6150	9250
170	2000	4050	6100	2450	4950	7450	2950	5850	8750	3150	6050	9100
180	2000	4000	6000	2450	4900	7350	2900	5750	8600	3100	5950	8950
190	1950	3950	5900	2400	4800	7200	2850	5650	8500	3050	5850	8800
200	1900	3850	5800	2350	4700	7050	2800	5550	8350	3000	5750	8650
210	1900	3800	5700	2300	4650	6950	2750	5450	8200	2950	5700	8550
220	1850	3750	5650	2250	4550	6850	2700	5400	8100	2900	5600	8400
230	1850	3700	5550	2250	4500	6750	2650	5300	8000	2850	5500	8300
240	1800	3650	5450	2200	4400	6650	2600	5250	7850	2850	5450	8150
250	1800	3600	5400	2150	4350	6550	2550	5150	7750	2800	5350	8050

Notes:

1. These are formwork selection tables only. Maximum slab spans in these tables shall be designed by a qualified structural engineer.
2. Use BONDEK® design software for support widths other than 100mm.
3. 1 kPa Live Load due to stacked materials is used - this shall be indicated on formwork documentation and controlled on-site.
4.  The availability of 0.9mm BMT BONDEK® is subject to enquiry.
5. Refer to General Engineering Notes when using these tables.

Maximum slab spans, mm

BONDEK® sheets continuous over 3 or more slab spans

Formwork deflections limits L/240 (Visual appearance important)

Slabs spans ratio up to 1.1.2

Slab Depth D (mm)	0.6 BMT BONDEK® No of props per span			0.75 BMT BONDEK® No of props per span			0.9 BMT BONDEK® No of props per span			1.0 BMT BONDEK® No of props per span		
	0	1	2	0	1	2	0	1	2	0	1	2
100	2350	4900	7250	2600	5350	8000	2800	5700	8550	2900	5950	8900
110	2250	4650	7000	2550	5200	7800	2700	5550	8300	2800	5750	8650
120	2150	4450	6700	2450	5050	7600	2650	5400	8100	2750	5600	8400
130	2100	4300	6500	2400	4900	7400	2550	5250	7900	2650	5450	8150
140	2000	4150	6250	2300	4750	7150	2500	5100	7650	2600	5300	7950
150	1950	4050	6050	2250	4600	6950	2400	4950	7450	2500	5150	7700
160	1900	3900	5900	2200	4500	6750	2350	4800	7250	2450	5000	7550
170	1850	3800	5700	2150	4350	6550	2300	4700	7050	2400	4900	7350
180	1800	3700	5550	2050	4250	6400	2250	4600	6900	2350	4800	7200
190	1750	3600	5400	2000	4150	6250	2200	4500	6750	2300	4700	7050
200	1700	3500	5300	2000	4050	6100	2150	4400	6600	2250	4600	6900
210	1650	3450	5150	1950	4000	6000	2100	4300	6450	2200	4500	6750
220	1650	3350	5050	1900	3900	5850	2050	4200	6350	2150	4400	6650
230	1600	3300	4950	1850	3800	5750	2000	4150	6250	2100	4350	6500
240	1550	3200	4850	1800	3750	5650	2000	4050	6100	2050	4250	6400
250	1550	3150	4750	1800	3700	5550	1950	4000	6050	2050	4200	6300

Maximum slab spans, mm

BONDEK® sheets continuous over 3 or more slab spans

Formwork deflections limits L/130 (Visual appearance not important)

Slabs spans ratio up to 1.1.2

Slab Depth D (mm)	0.6 BMT BONDEK® No of props per span			0.75 BMT BONDEK® No of props per span			0.9 BMT BONDEK® No of props per span			1.0 BMT BONDEK® No of props per span		
	0	1	2	0	1	2	0	1	2	0	1	2
100	2350	4750	7150	2900	5850	8750	3350	6800	10000	3450	7050	10000
110	2300	4650	6950	2850	5700	8550	3250	6600	9950	3350	6850	10000
120	2250	4500	6800	2750	5550	8350	3150	6450	9700	3300	6700	10000
130	2200	4450	6650	2700	5400	8150	3100	6300	9500	3200	6550	9850
140	2150	4300	6500	2650	5300	7950	3050	6200	9300	3150	6400	9650
150	2100	4250	6350	2600	5200	7800	2950	6050	9100	3100	6300	9450
160	2050	4150	6250	2500	5050	7600	2900	5950	8450	3000	6150	9250
170	2000	4050	6100	2450	4950	7450	2850	5850	8750	2950	6050	9100
180	2000	4000	6000	2450	4900	7350	2800	5750	8600	2900	5950	8950
190	1950	3950	5900	2400	4800	7200	2750	5650	8500	2850	5850	8800
200	1900	3850	5800	2350	4700	7050	2700	5550	8350	2850	5750	8650
210	1900	3800	5700	2300	4650	6950	2700	5450	8200	2800	5700	8550
220	1850	3750	5650	2250	4550	6850	2650	5400	8100	2750	5600	8400
230	1850	3700	5550	2250	4500	6750	2600	5300	8000	2700	5500	8300
240	1800	3650	5450	2200	4400	6650	2550	5250	7850	2650	5450	8150
250	1800	3600	5400	2150	4350	6550	2500	5150	7750	2600	5350	8050

Notes:

1. These are formwork selection tables only. Maximum slab spans in these tables shall be designed by a qualified structural engineer.
2. Use BONDEK® design software for support widths other than 100mm.
3. 1 kPa Live Load due to stacked materials is used - this shall be indicated on formwork documentation and controlled on-site.
4.  The availability of 0.9mm BMT BONDEK® is subject to enquiry.
5. Refer to General Engineering Notes when using these tables.

ACCESSORIES

Figure 4
BONDEK® accessories.

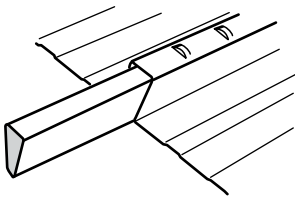

BONFILL®
Polystyrene foam stops concrete and air entering ends of ribs. Stock length: 1200mm. Required: 300mm per sheet of BONDEK®.

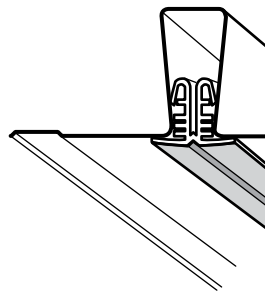

BONSTRIP®
Plastic trim to cover gaps formed by ribs. Used when underside of BONDEK® forms an exposed ceiling. Stock length: 3000mm. Allows plasterboard to be fixed to BONDEK®.



RIB END PLUG (QLD, VIC & NSW)
Polyethylene end plug minimises concrete slurry seeping through.

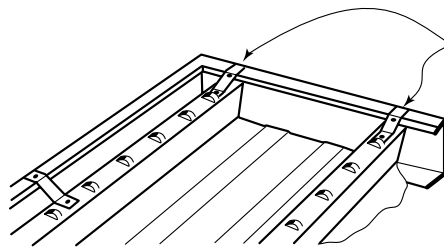

Brackets from builders strapping
Straps formed on-site using builders strapping to secure top flange of the Edgeform.
25mm x 1.0mm fixed with #10-16x16 hex. head Tek screws with drill point. Required: one every 600mm or less if aesthetics are required.

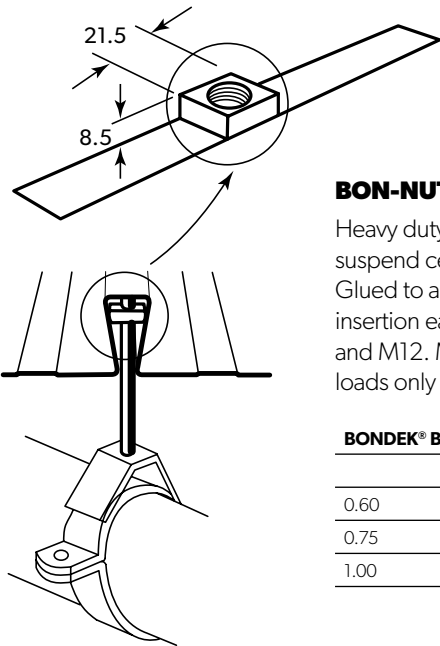

BON-NUT
Heavy duty square nut to suspend ceilings or services. Glued to a paper strip it makes insertion easy. Threads: M8, M10 and M12. M6 is available for light loads only (2.7 kN or less).

BONDEK® BMT	Safe Load
	kN
0.60	3.9
0.75	4.4
1.00	6.7

EDGEFORM
A galvanised section that creates a permanent formwork at the slab edges—cut, mitred and screwed on site. 1.0mm BMT - up to 145mm slab depth. 1.2mm BMT - 150 - 175mm slab depth.

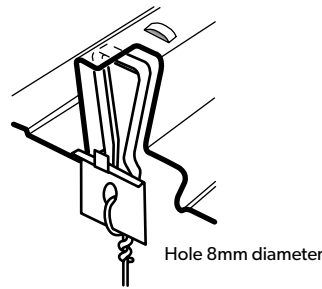

BONWEDGE®
Lightweight bracket for rods to suspend ceilings or services (other than fire sprinkler systems). Max. load: 100kg.

Configuration	Loading	Safe Load
kN		
Single BONWEDGE®	Eccentric	1.0
Double BONWEDGE®	Eccentric	1.3
Double BONWEDGE®	Central	1.7

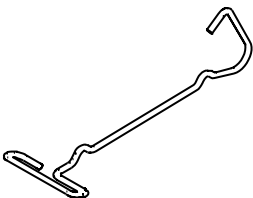

PT HOLD DOWN CLIP
Allows hold down of post-tensioning ducts.

BONDEK® INSTALLATION AND CONSTRUCTION



Step 1: Open BONDEK® sheet bundles.



Step 2: Place props if required.



Step 3: Trim BONDEK® sheets if required and place.



Step 4: Fix BONDEK® sheets to steel beams if required.

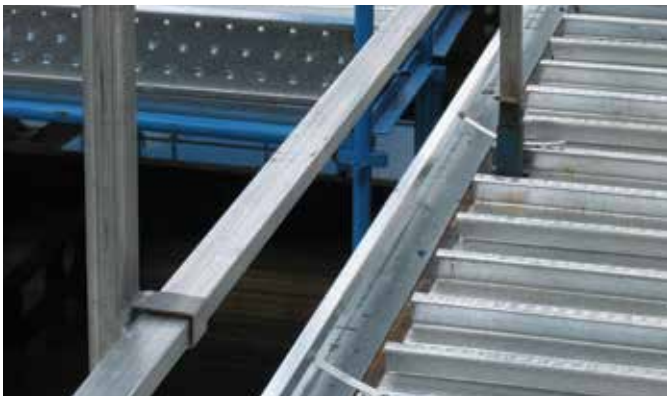

Step 5: Fix steel Edgeform.



Step 6: Cut penetration.



Step 7: Place reinforcement and post tensioning if required.



Step 7a) PT Hold Down Clip.



Step 8: Place concrete.



Step 9: Allow slab to cure and remove props.

Step 10: Install services and ceilings with BONDEK® accessories.



Step 10a) BONWEDGE®.



Step 10b) Bon-nut.



Step 10c) BONSTRIP®.

GENERAL ENGINEERING NOTES

1. At a minimum, BONDEK® shall be secured at every pan at ends of sheets and also at permanent supports. Failure to secure BONDEK® at supports may lead to excessive deformation and structural failure.
 - Suitable fixing methods should be used such as spot welds, self drilling screws or drive nails. There are two sets of formwork tables:
 - Ratio of two adjacent slab spans are equal
 - The ratio of the longer slab span to the shorter slab span does not exceed 1.2, that is longer span/shorter span ≤ 1.2
2. The tables shall be used for normal density concrete (2400kg/m³).
3. The lines of support shall extend across the full width of the sheeting and have a minimum bearing 50mm at the ends of the sheets and 100mm at intermediate supports over which sheeting is continuous, including at props. 25mm minimum bearing length at the ends of sheets is acceptable in concrete frame construction.
4. The tables are based on the following maximum construction loads:
 - Workmen and equipment = 100kg/m²
 - Mounding of concrete = 300kg/m² over an area of 1.6 x 1.6m and zero over the remainder.
 - Stacking of material on BONDEK® sheets before placement of concrete only = 100kg/m²
5. LYSAGHT BONDEK® sheets are readily available, custom-cut, in various lengths. Please contact your local service centre for details.
6. No loads from stacked materials after pour are allowed until the concrete has set.
7. The sheets shall not be end spliced or jointed.
8. Ponding dead load - the additional concrete due to ponding of the concrete from the sheeting deflection has been included.
9. Supports shall be effectively rigid and strong to support construction loads.
10. The sheeting shall not have cantilever portions.
11. Wet concrete deflection of BONDEK® = L/240 or L/130, where L is the distance between centres of props, or permanent supports where there are no props.
12. The information contained in the publication is intended for guidance only. This information to be used only in conjunction with a consulting structural engineer.
13. Further details can be sought from the LYSAGHT® publication BONDEK® Design & Construction Manual or consulting Steel Direct on 1800 641 417.

PRODUCT DESCRIPTIONS

- All descriptions, specifications, illustrations, drawings, data, dimensions and weights contained in this catalogue, all technical literature and websites containing information from Lysaght are approximations only. They are intended by Lysaght to be a general description for information and identification purposes and do not create a sale by description. Lysaght reserves the right at any time to:

- (a) supply Goods with such minor modifications from its drawings and specifications as it sees fit; and
- (b) alter specifications shown in its promotional literature to reflect changes made after the date of such publication.

DISCLAIMER, WARRANTIES AND LIMITATION OF LIABILITY

- This publication is intended to be an aid for all trades and professionals involved with specifying and installing Lysaght products and not to be a substitute for professional judgement.
- Terms and conditions of sale available at local Lysaght sales offices.
- Except to the extent to which liability may not lawfully be excluded or limited, BlueScope Steel Limited will not be under or incur any liability to you for any direct or indirect loss or damage (including, without limitation, consequential loss or damage such as loss of profit or anticipated profit, loss of use, damage to goodwill and loss due to delay) however caused (including, without limitation, breach of contract, negligence and/or breach of statute), which you may suffer or incur in connection with this publication.

FOR YOUR NEAREST SUPPLIER VISIT:

WWW.LYSAGHT.COM

FOR SALES ENQUIRIES CALL 13 30 38

FOR TECHNICAL ENQUIRIES CALL 1800 641 417

© BlueScope Steel Limited November 2019.

® product and colour names are registered trade marks of BlueScope Steel Limited. ™ product and colour names are trade marks of BlueScope Steel Limited ABN 16 000 011 058. The LYSAGHT® range of products is exclusively made by BlueScope Steel Limited trading as Lysaght.

